



IWC-XWW-EX-AT-01
SCALE 1:2

IWC-XWW-EX-AT-02
SCALE 1:2

IWC-XWW-EX-AT-03
SCALE 1:2

IWC-XWW-EX-AT-04
SCALE 1:2

©copyright

Revision	By	Date
-	-	-
-	-	-
-	-	-
-	-	-
-	-	-
-	-	-

Title
**Standard Details
Wall To Wall
External
Ambient Temperature
(15°C and Above)**

Checked By	AS	Scale	1:2
Drawn By	RV	Sheet size	A1
Issue date	16.01.2013	Revision	A
Drawing No.	IWC-XWW-EX-AT		
Sheet	1 of 9		

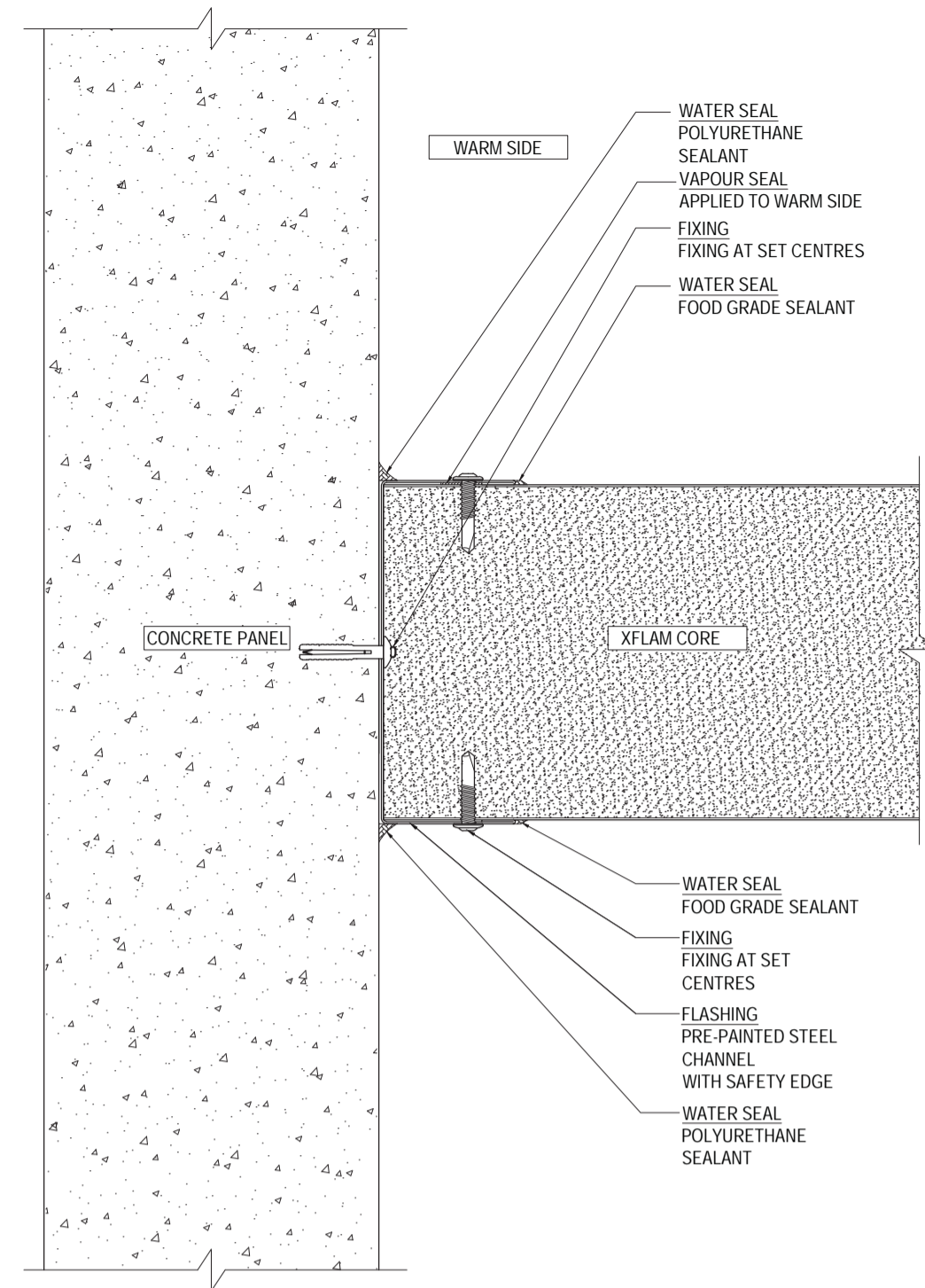

IWC-XWW-IN-AT-01
SCALE 1:2

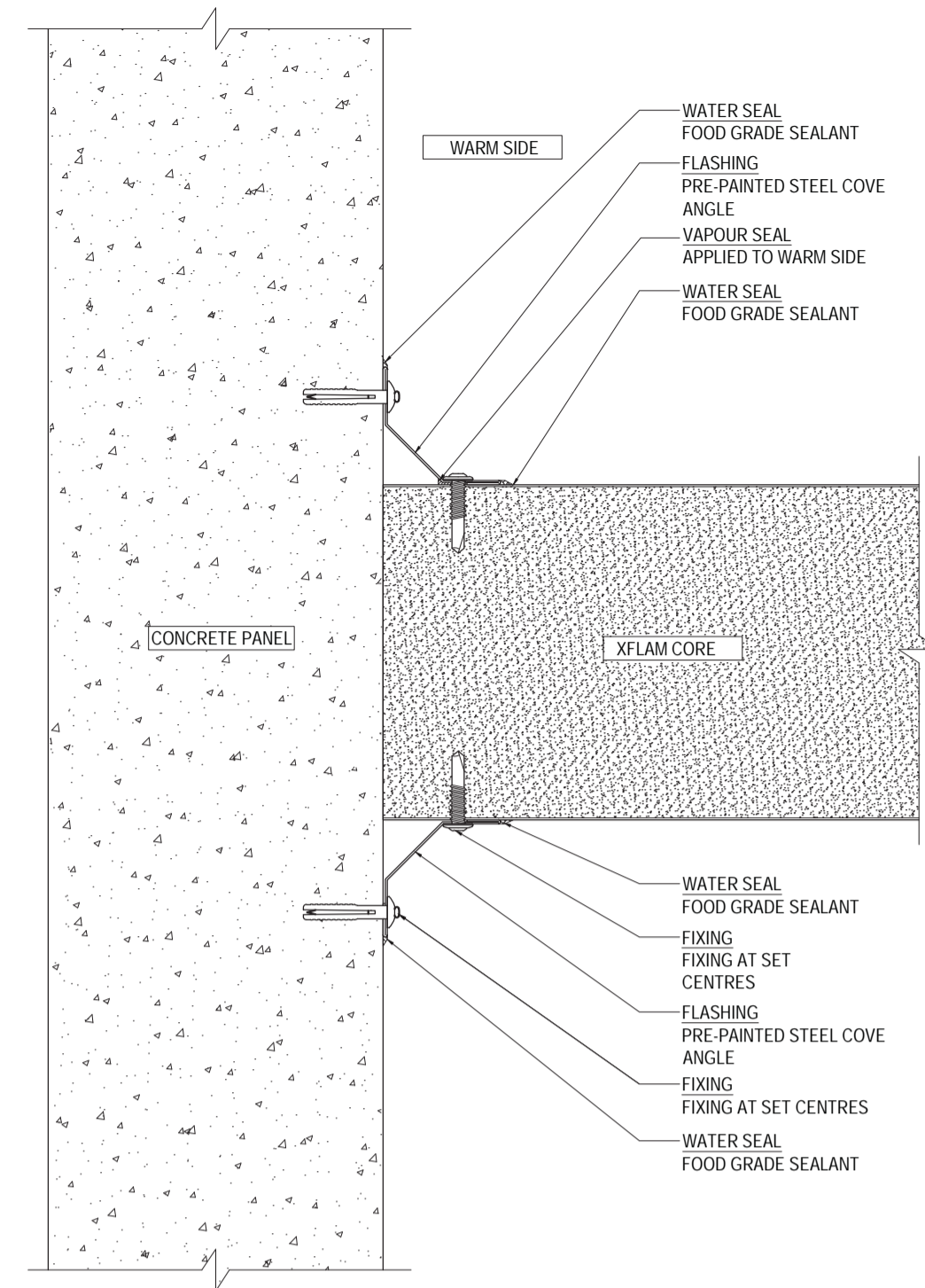

IWC-XWW-IN-AT-02
SCALE 1:2

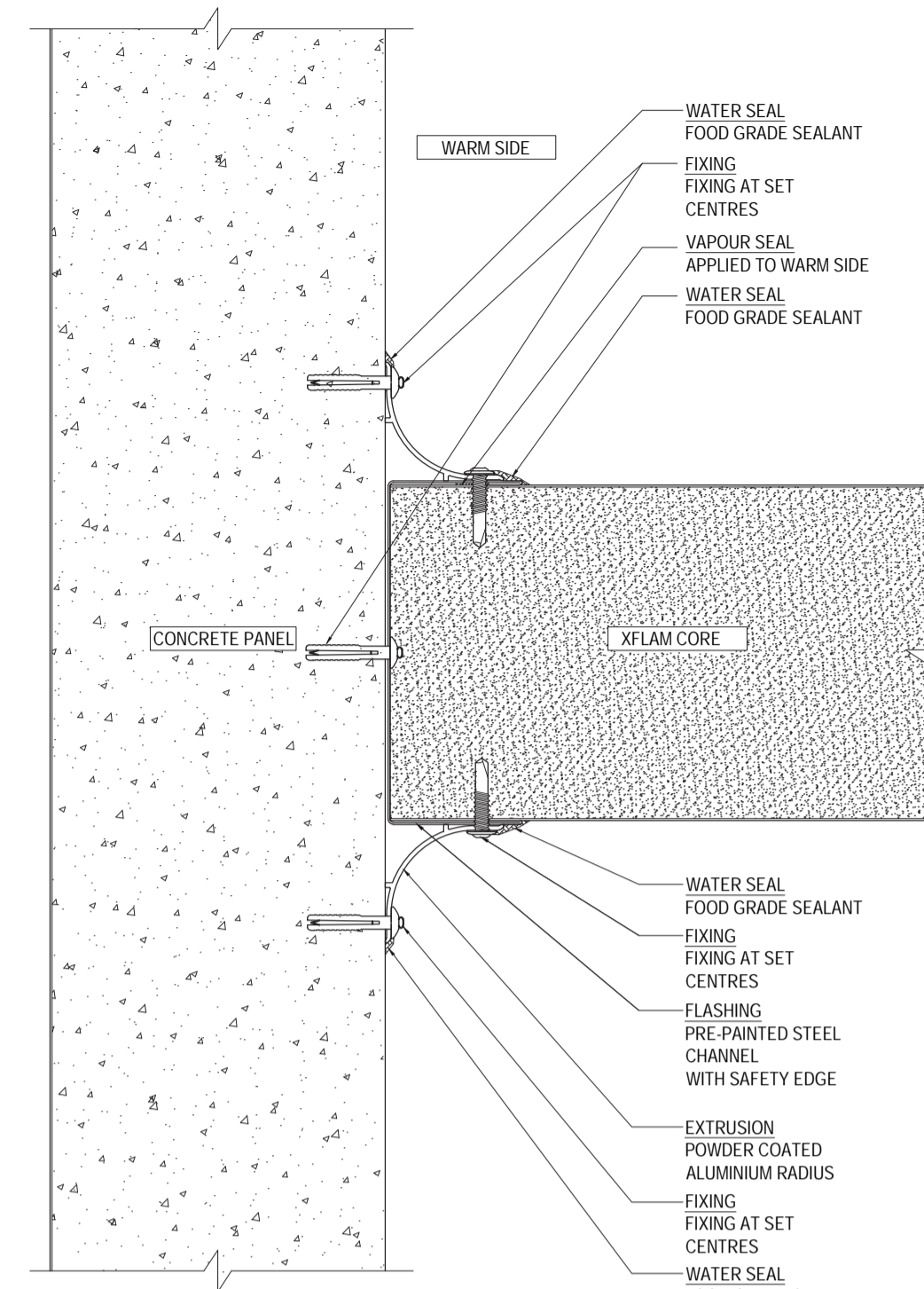

IWC-XWW-IN-AT-03
SCALE 1:2

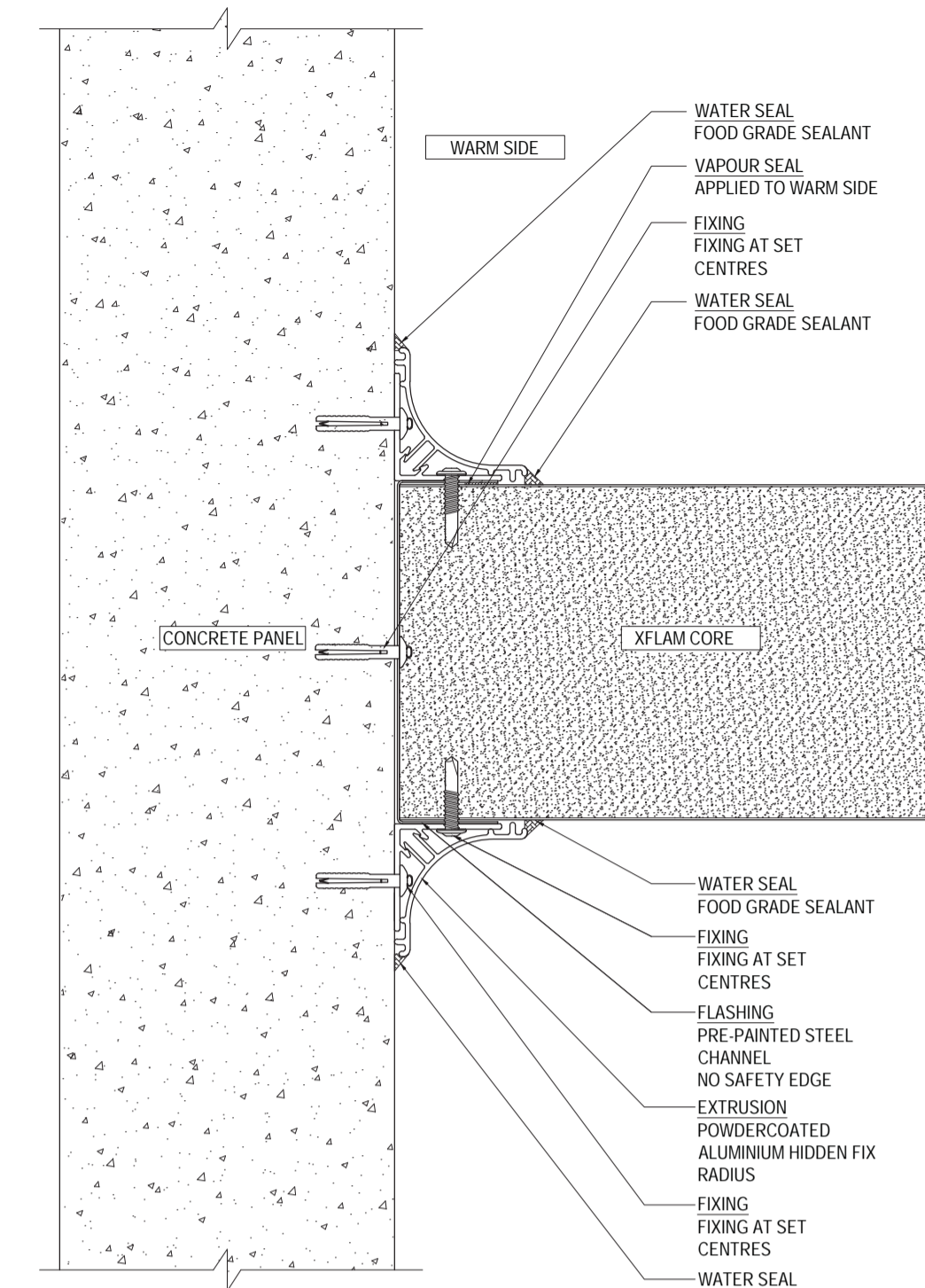

IWC-XWW-IN-AT-04
SCALE 1:2

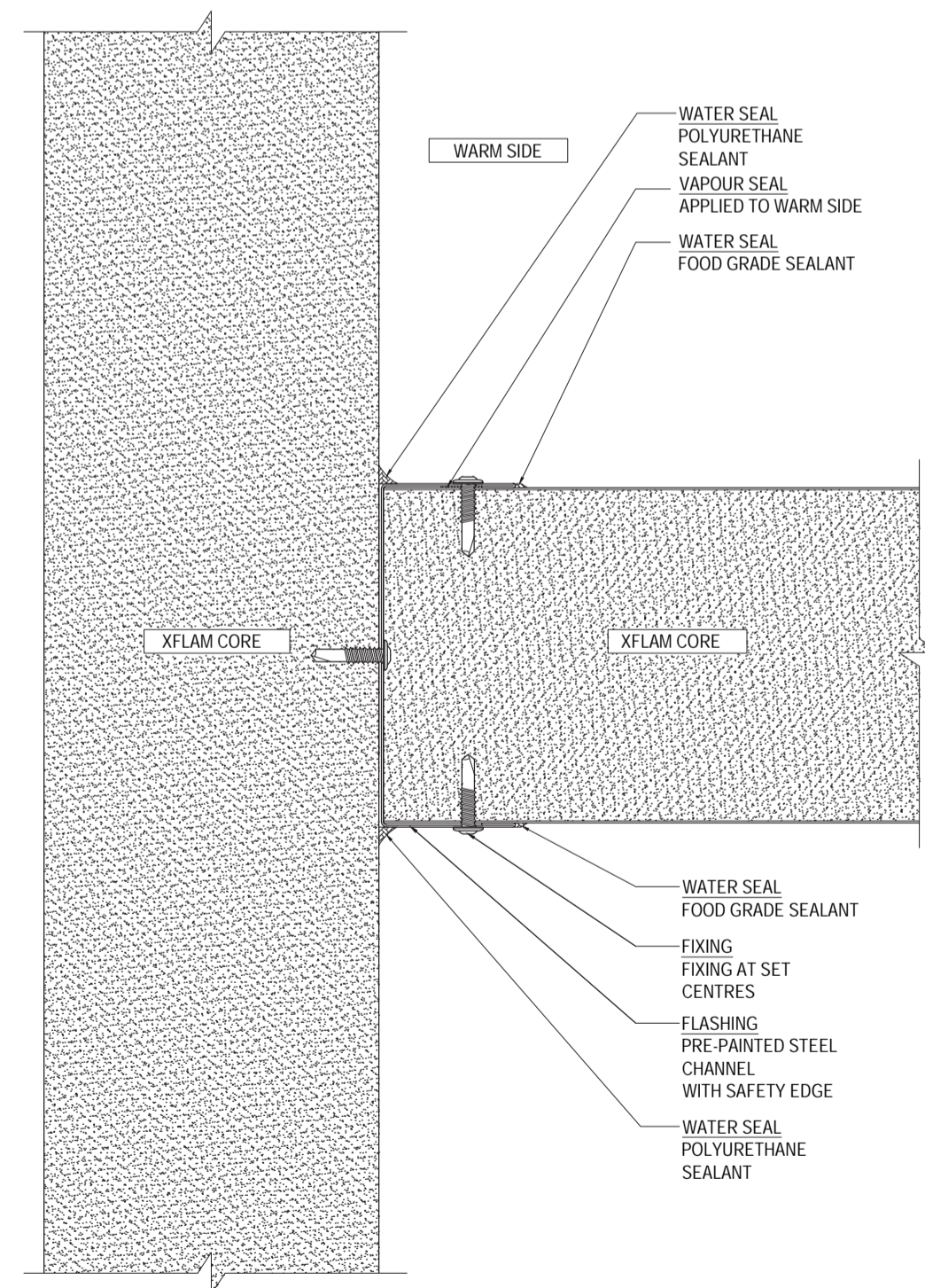

IWC-XWW-IN-AT-05
SCALE 1:2

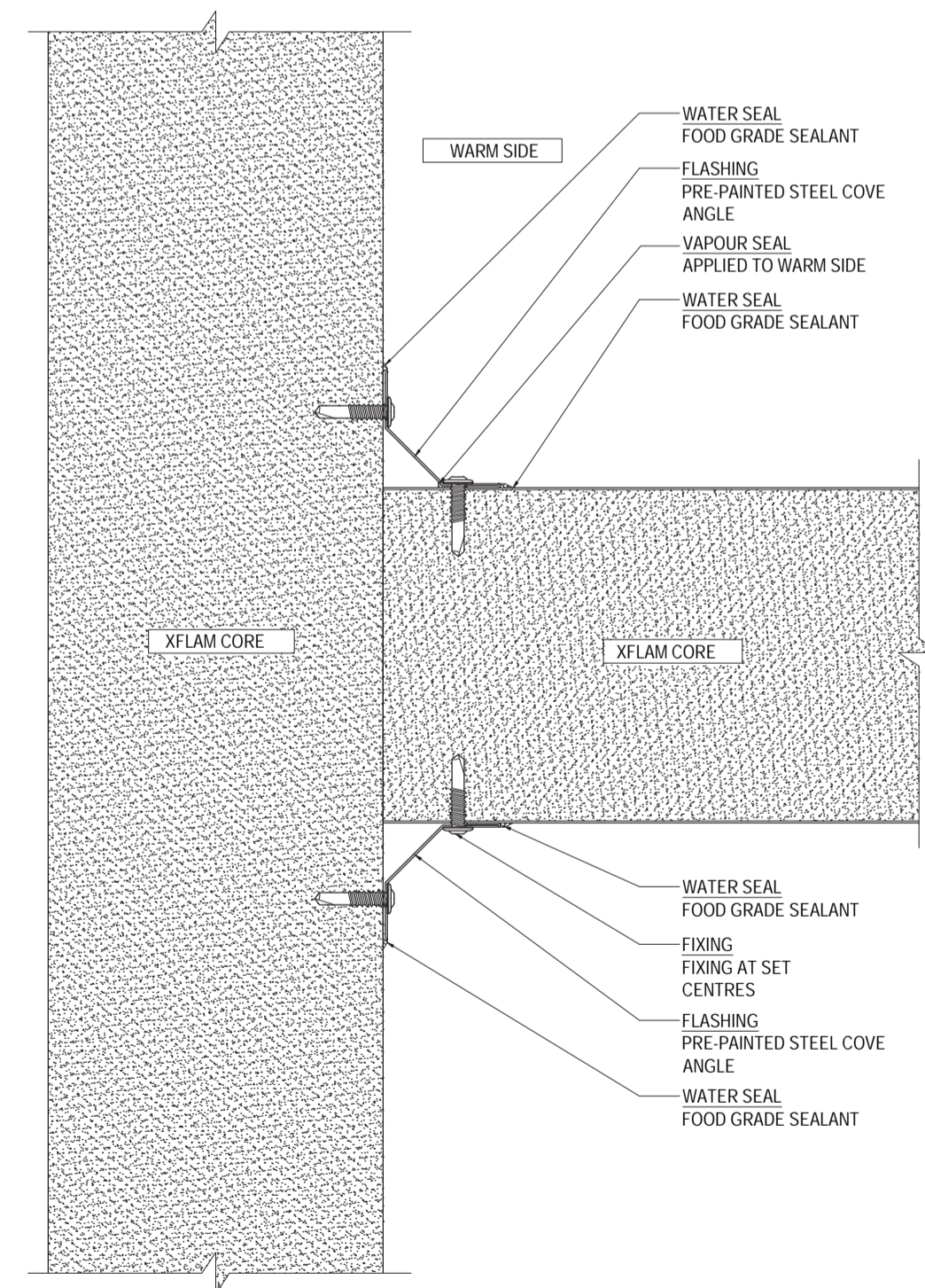

IWC-XWW-IN-AT-06
SCALE 1:2

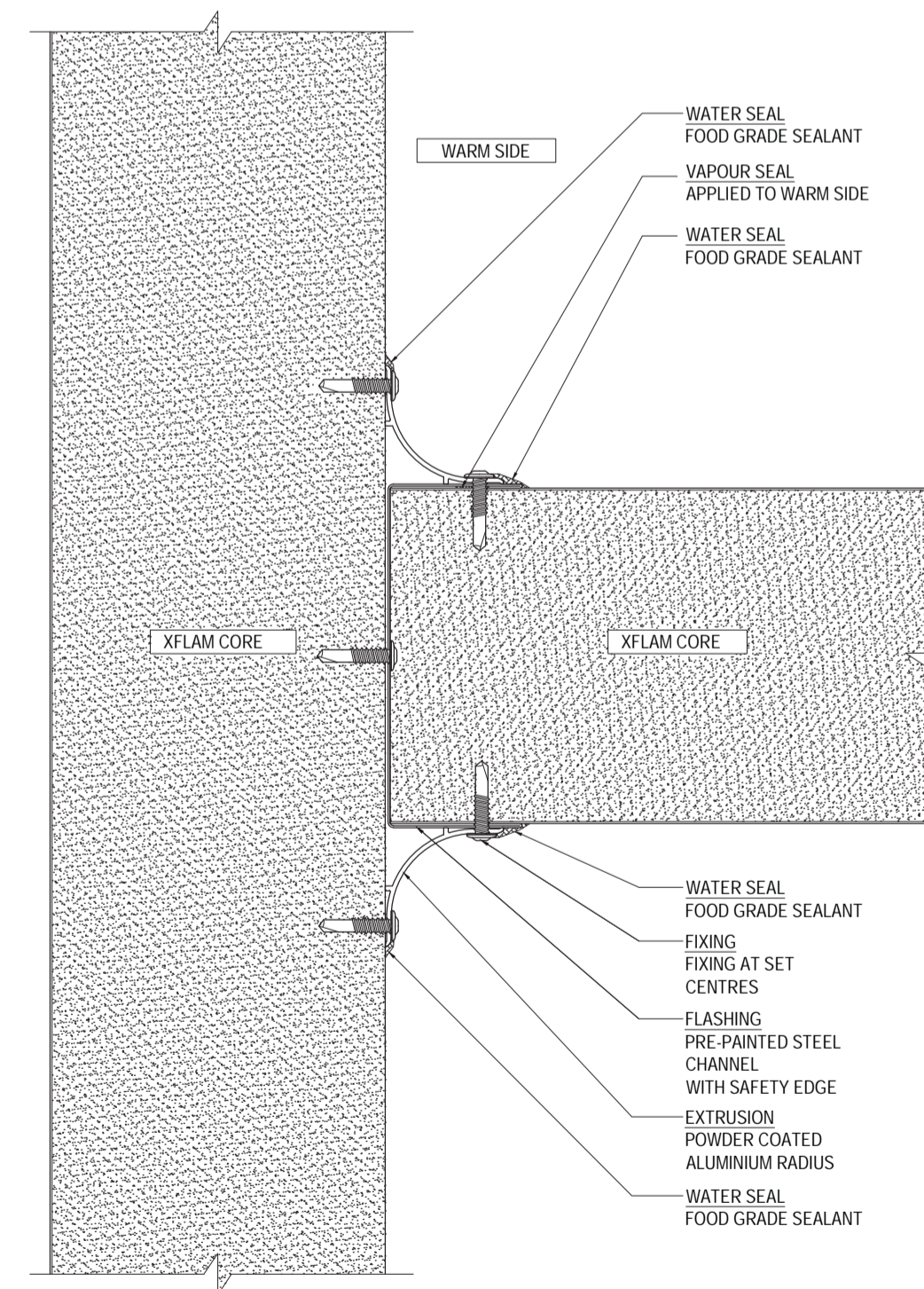

IWC-XWW-IN-AT-07
SCALE 1:2

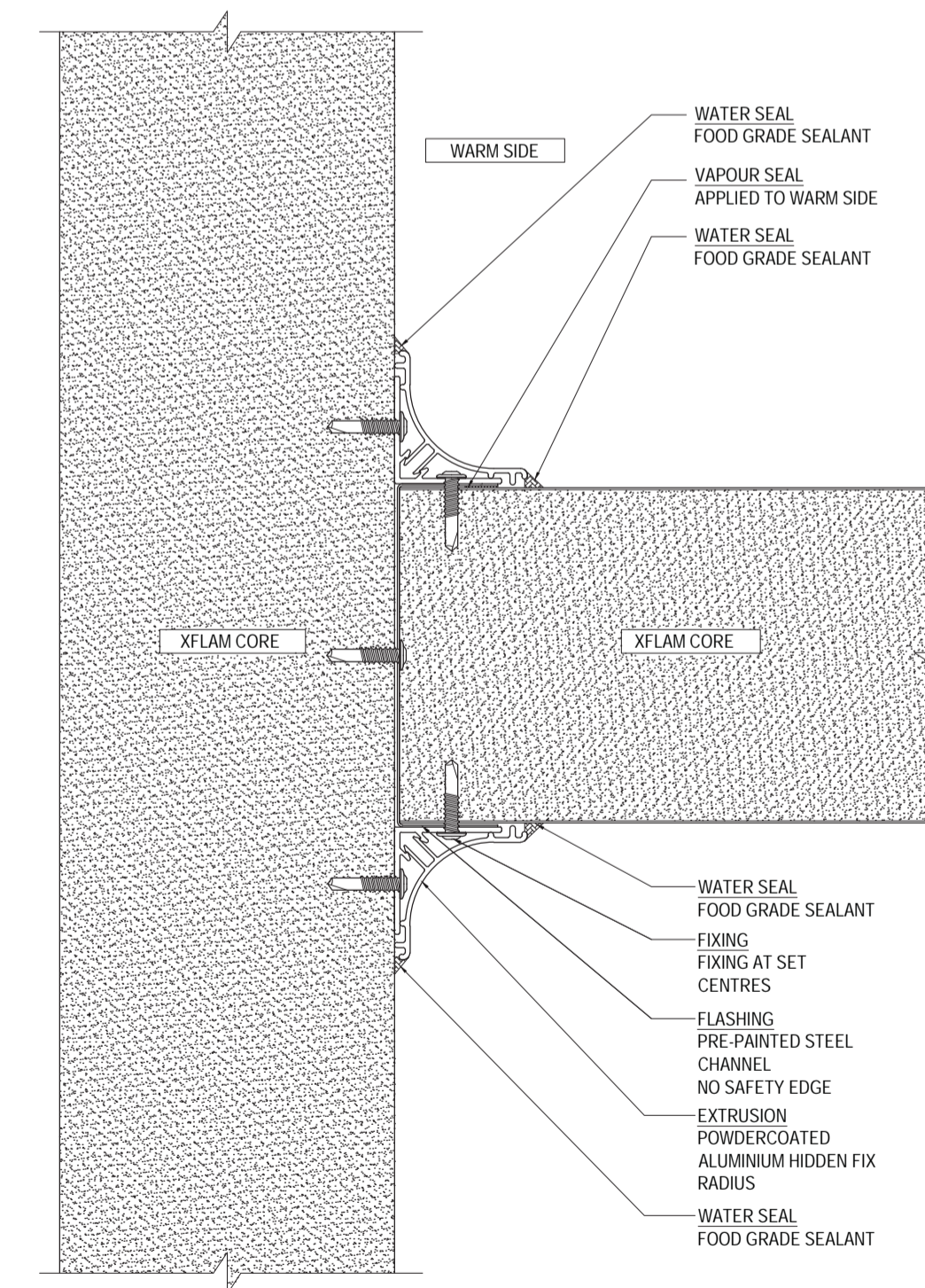

IWC-XWW-IN-AT-08
SCALE 1:2

©copyright

Revision	Description

Standard Details
Wall To Wall
Internal
Ambient Temperature
(15°C and Above)

Checked By	AS	Scale	1:2
Drawn By	RV	Sheet size	A1
Issue date	16.01.2013	Revision	A
Drawing No.	IWC-XWW-IN-AT		
Sheet	2 of 9		



© copyright

Revision		
-	-	-
-	-	-
-	-	-
-	-	-
-	-	-
-	-	-

Title
**Standard Details
Wall To Wall
External
Medium / Low Temperature
(-50°C - 15°C)**

<i>Checked By</i>	AS	<i>Scale</i>	1:2
<i>Drawn By</i>	RV	<i>Sheet size</i>	A1
<i>Issue date</i>	16.01.2013	<i>Revision</i>	A
<i>Drawing No.</i>	IWC-XWW-EX-ML		
<i>Sheet</i>	4 of 9		

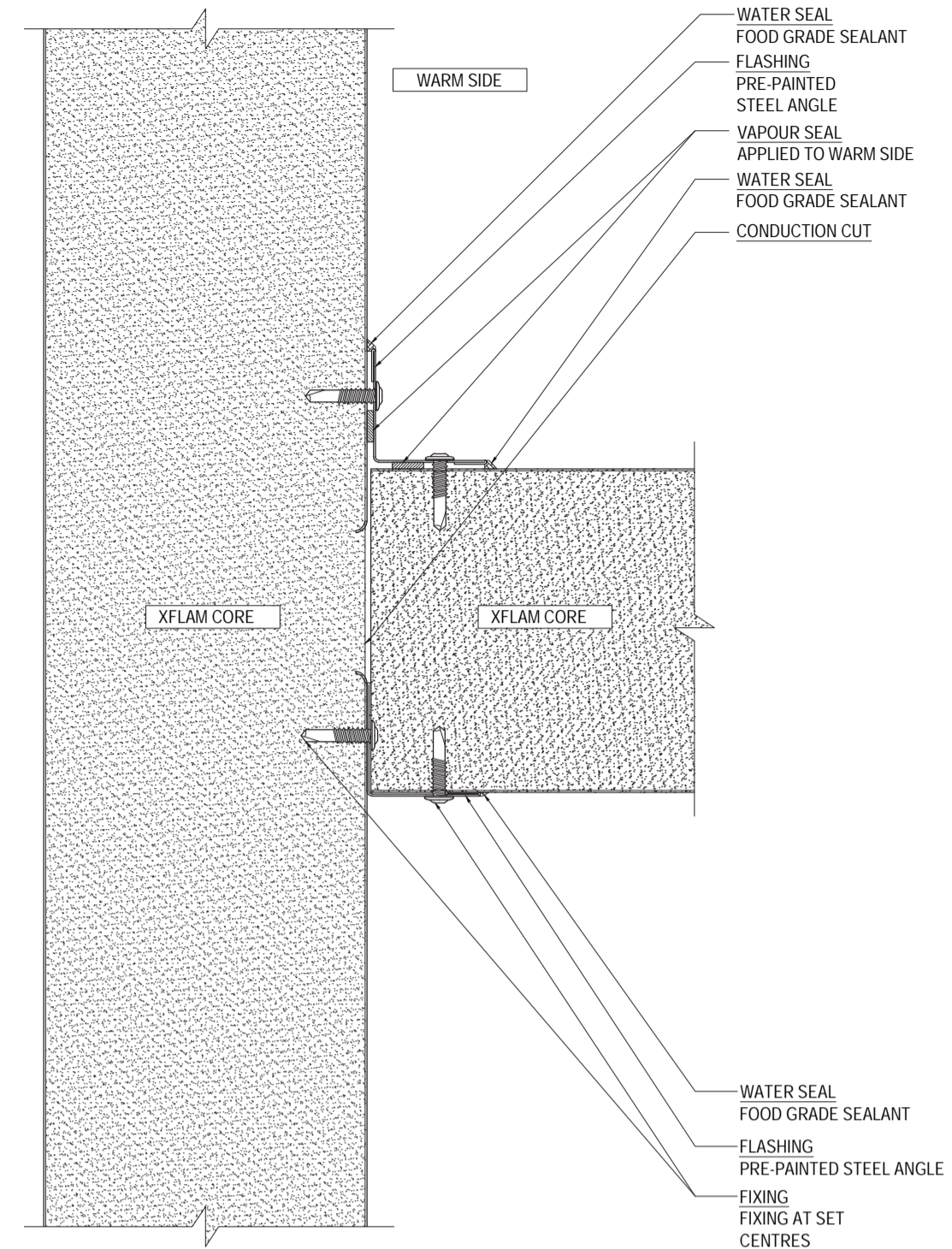

IWC-XWW-IN-ML-05
SCALE 1:2

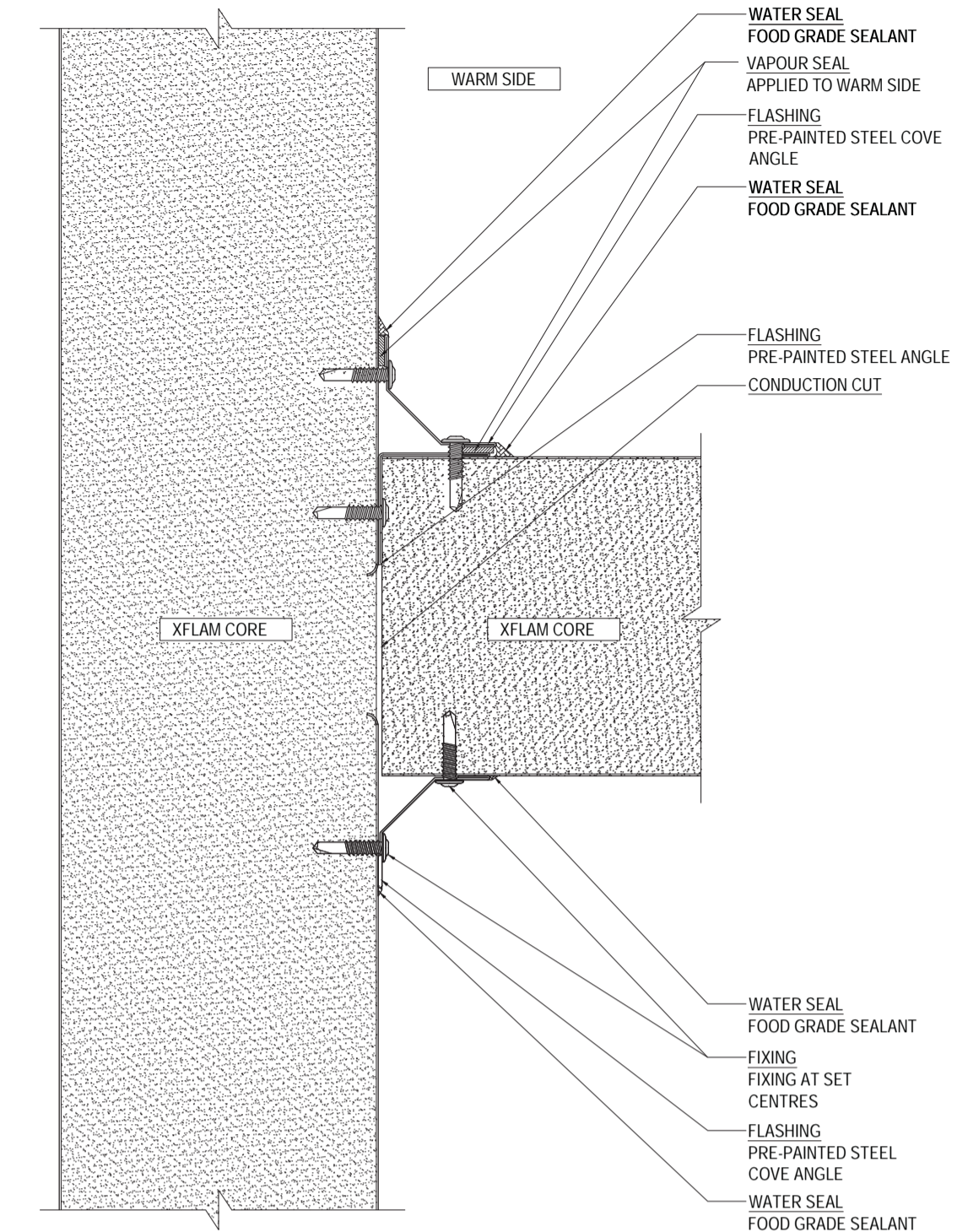

IWC-XWW-IN-ML-06
SCALE 1:2

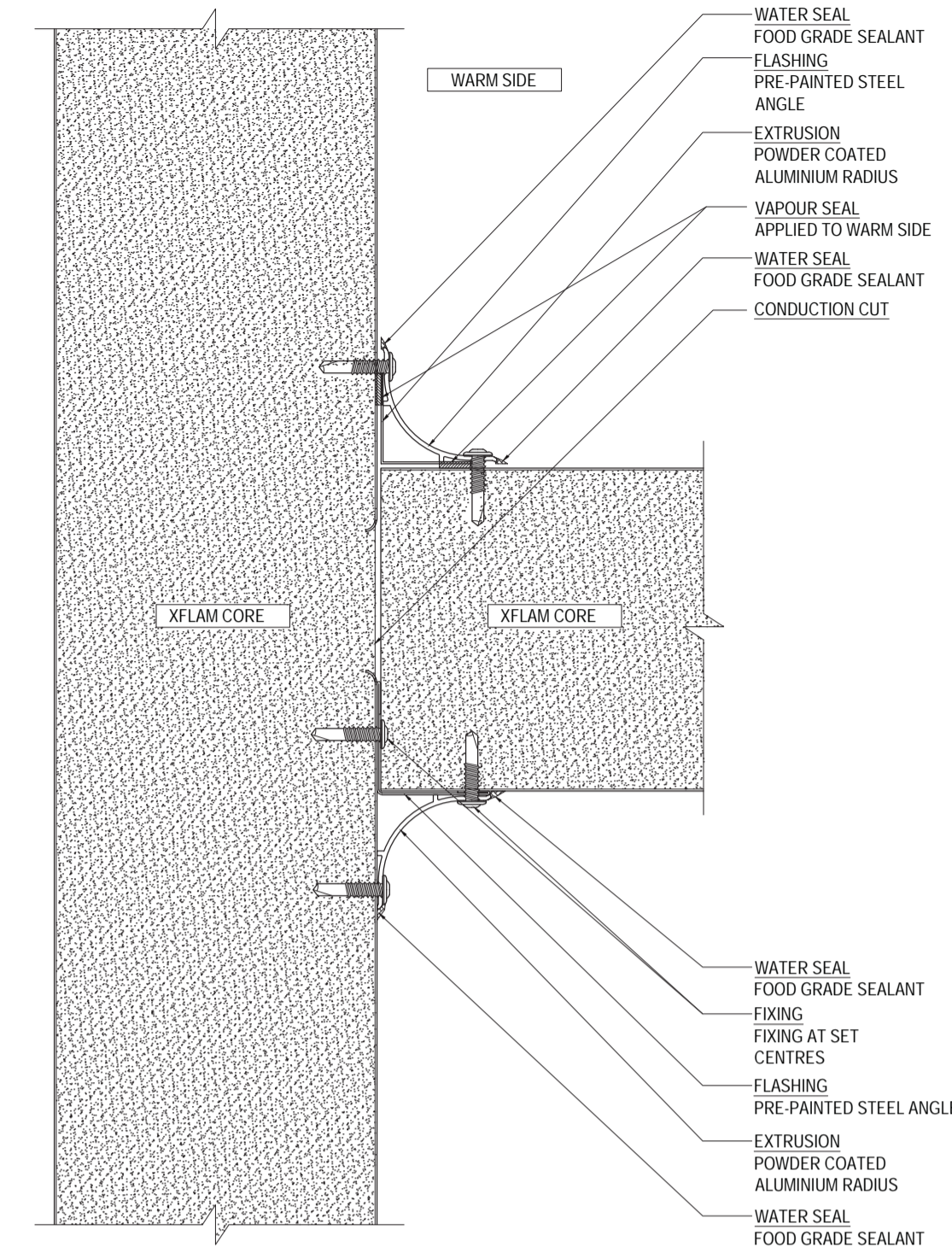

IWC-XWW-IN-ML-07
SCALE 1:2

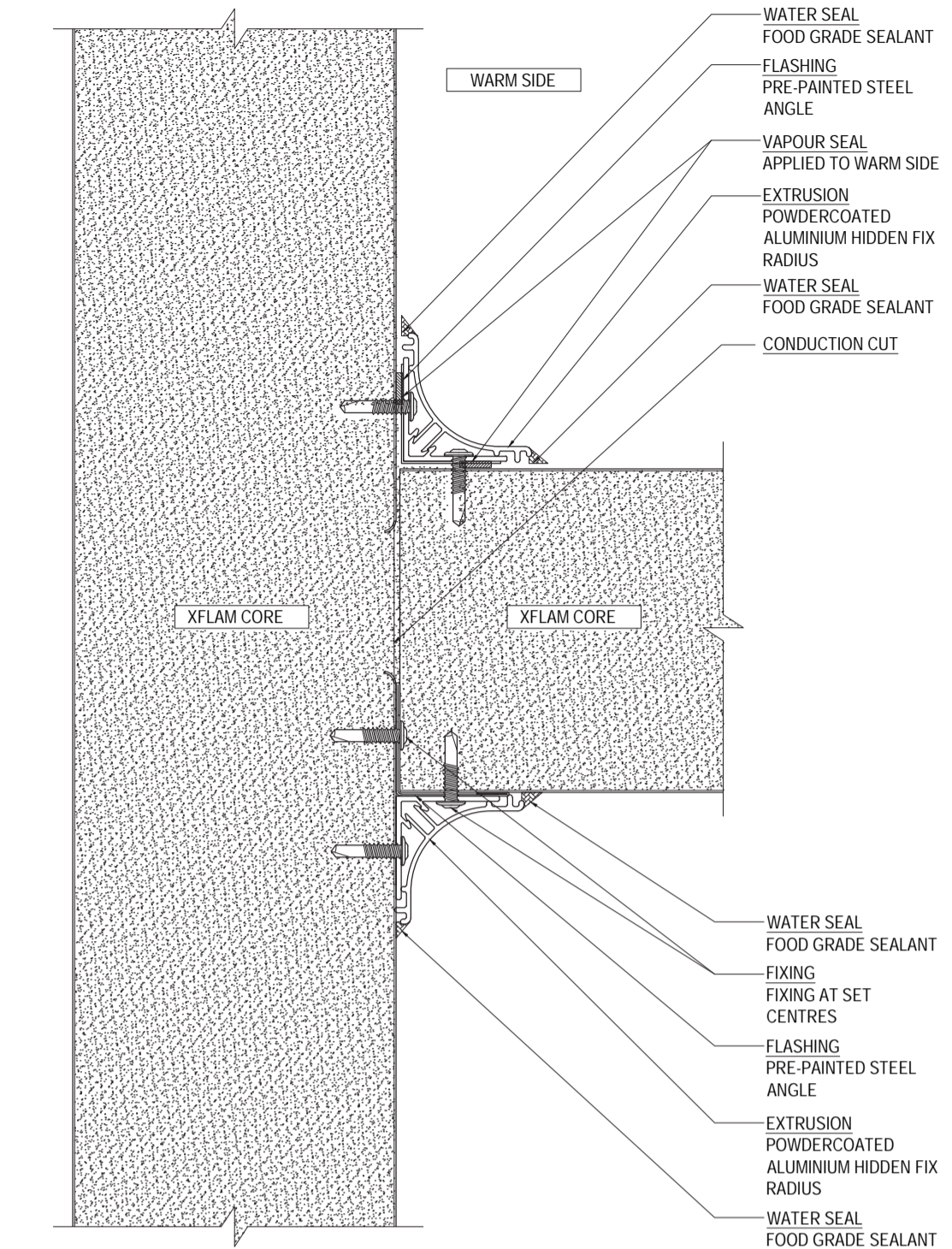

IWC-XWW-IN-ML-08
SCALE 1:2

©copyright

Revision	

Title
**Standard Details
 Wall To Wall
 Internal
 Medium / Low Temperature
 (-50°C - 15°C)**

Checked By	AS	Scale	1:2
Drawn By	RV	Sheet size	A1
Issue date	16.01.2013	Revision	A
Drawing No.	IWC-XWW-IN-ML		
Sheet	6 of 9		

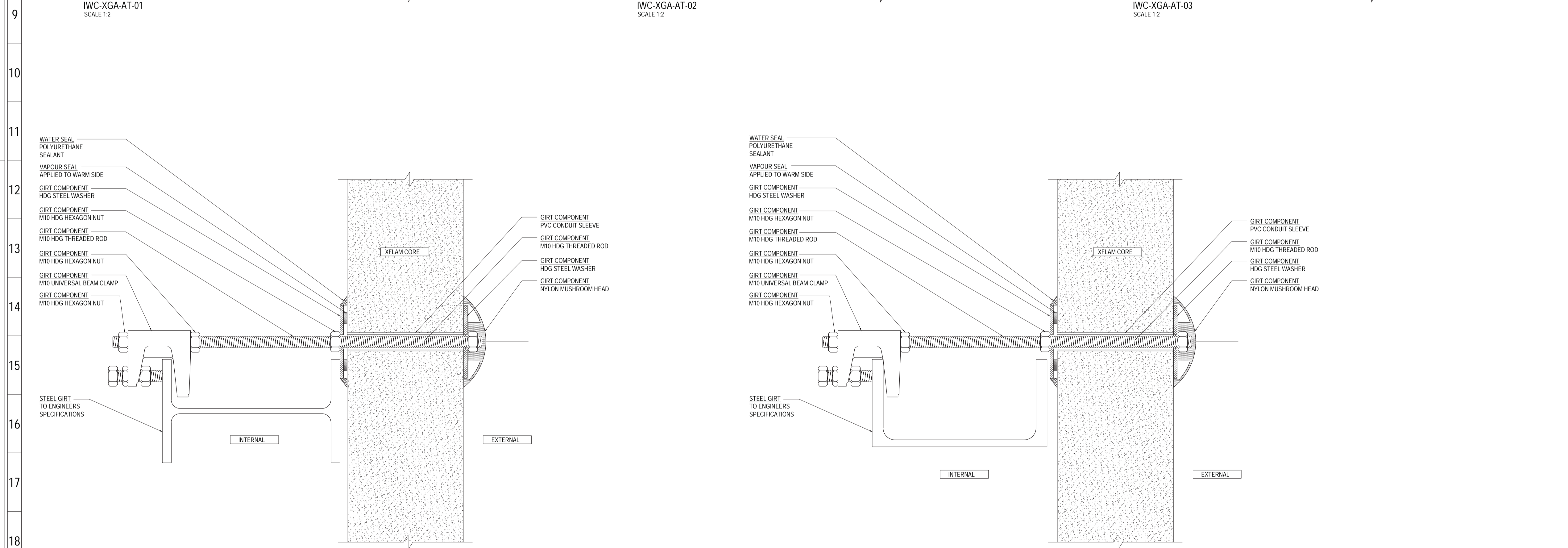
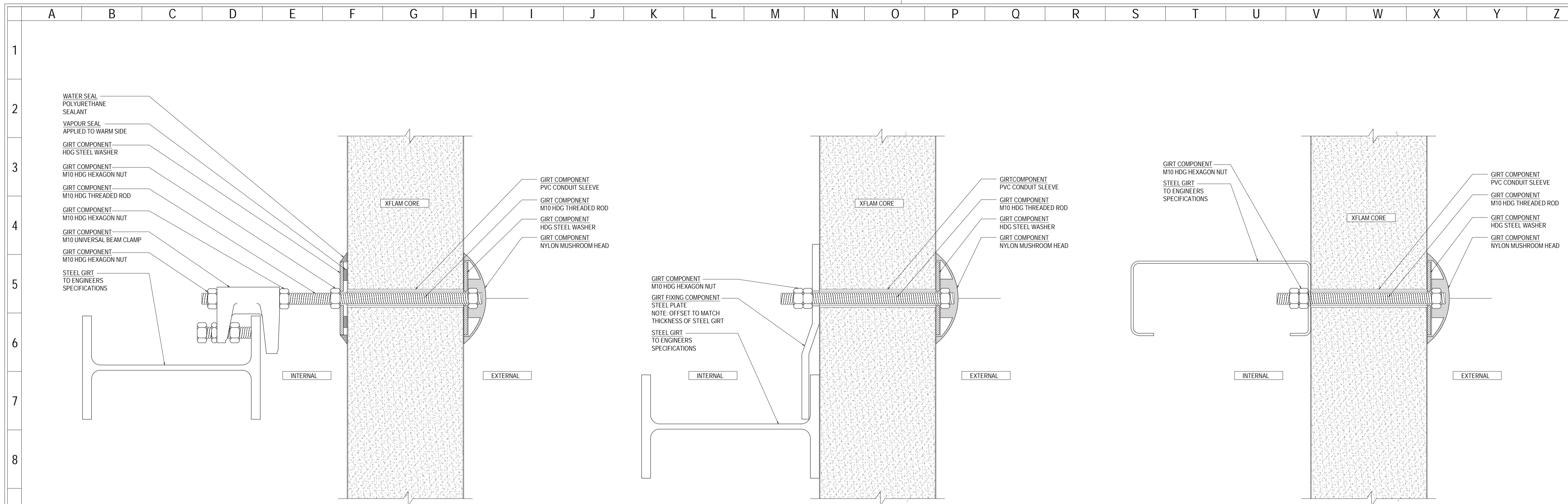

©copyright

Revision	Description	Date
-	-	-
-	-	-
-	-	-
-	-	-
-	-	-
-	-	-

Title

**Standard Details
Girt Assembly
Fixed
Ambient Temperature
(15°C and Above)**

Checked By	AS	Scale	1:2
Drawn By	RV	Sheet size	A1
Issue date	24.01.2013	Revision	A
Drawing No.	IWC-XGA-AT		
Sheet	7 of 9		

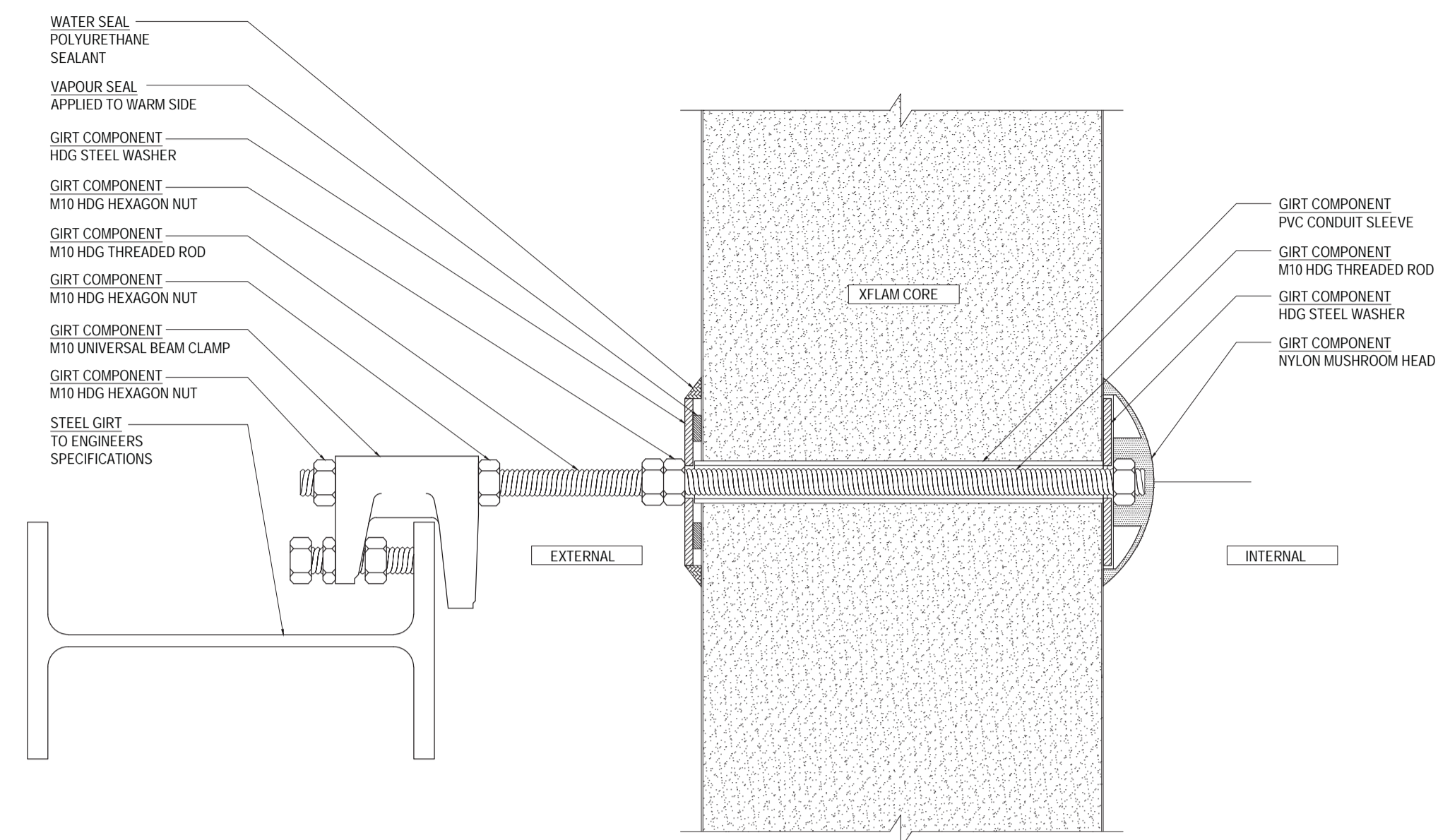

IWC-XGA-ML-01
SCALE 1:2

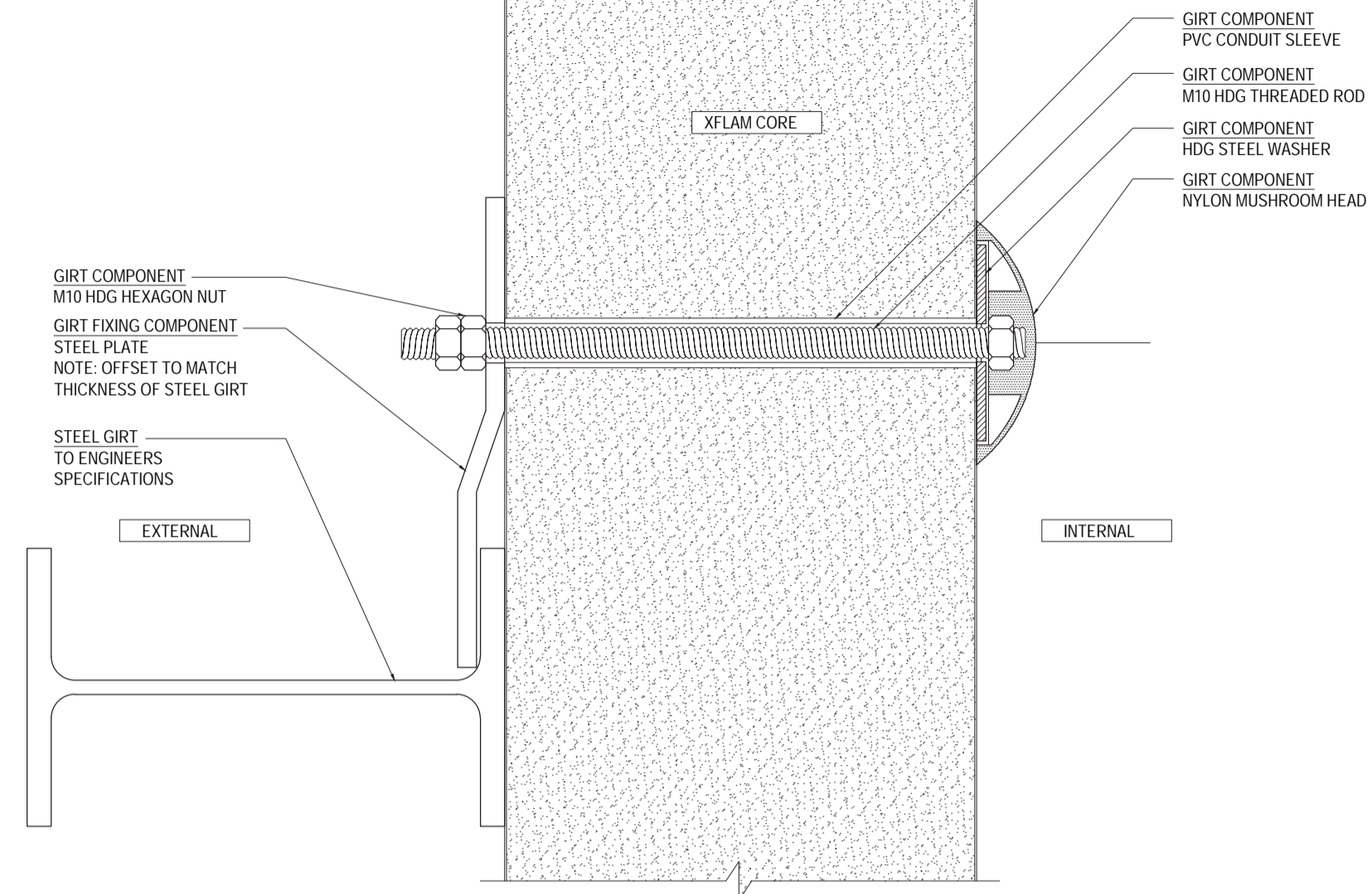

IWC-XGA-ML-02
SCALE 1:2

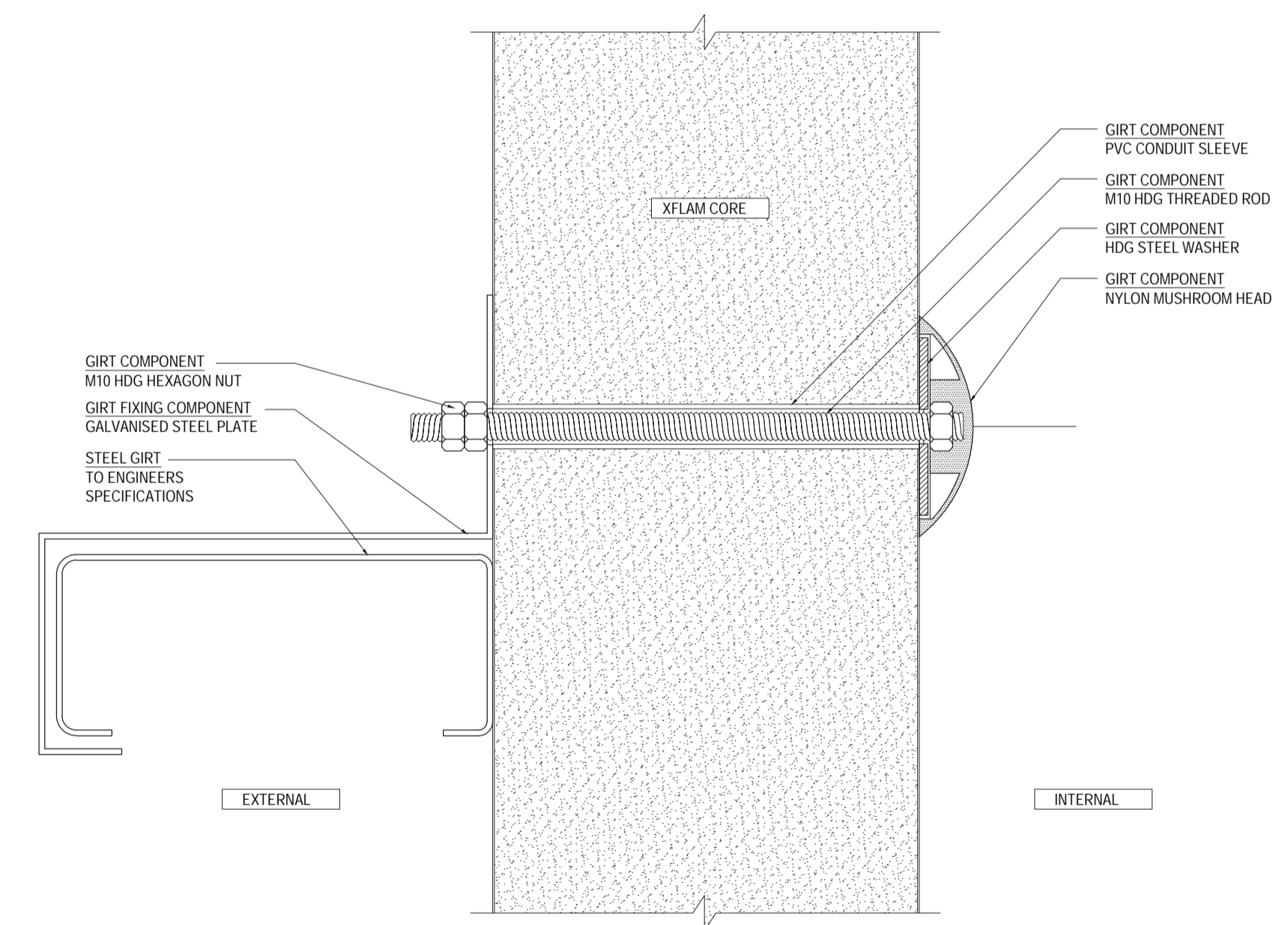

IWC-XGA-ML-03
SCALE 1:2

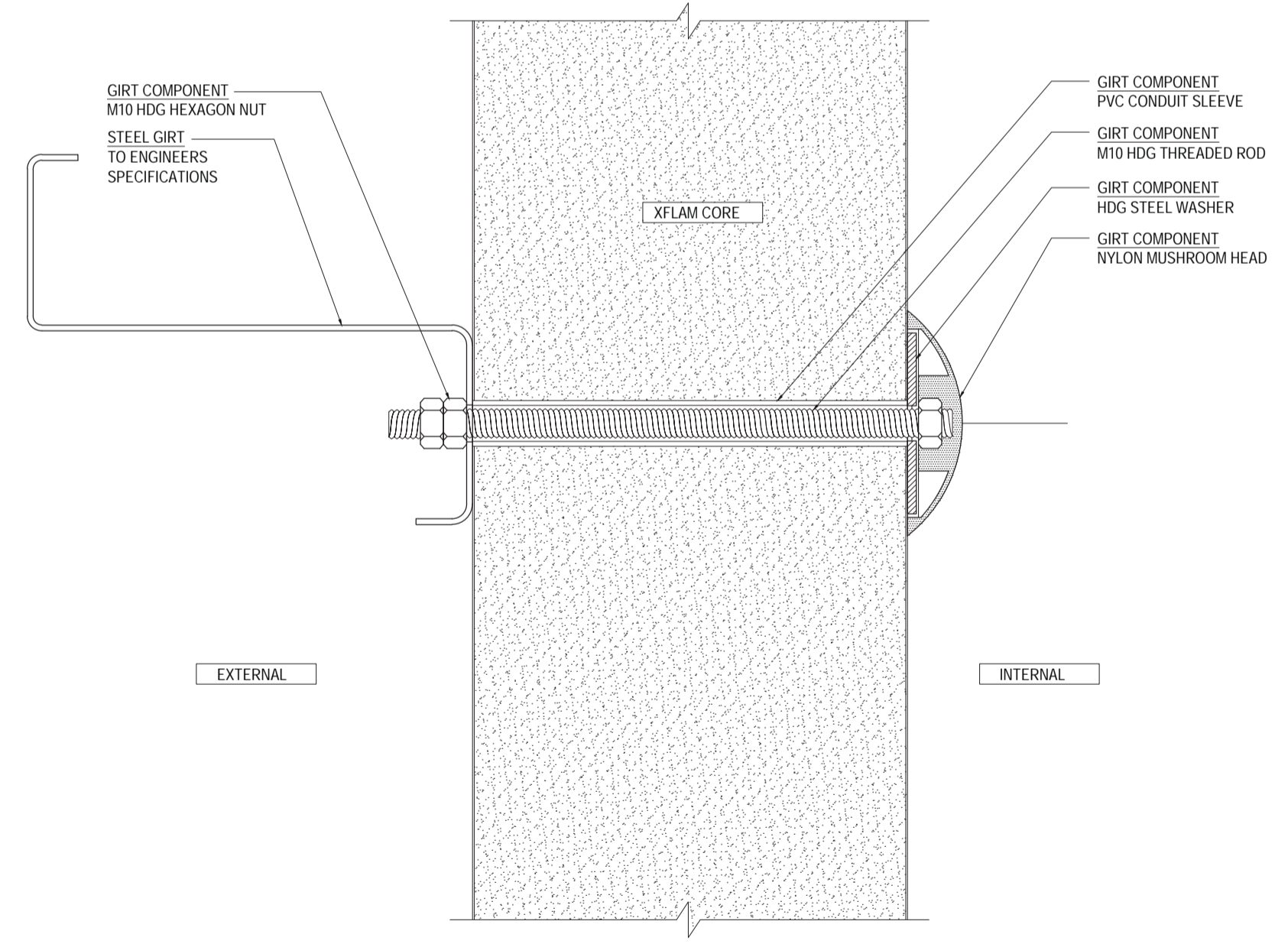

IWC-XGA-ML-04
SCALE 1:2

©copyright

Revision		
-	-	-
-	-	-
-	-	-
-	-	-
-	-	-
-	-	-

Title
Standard Details
Girt Assembly
Fixed
Medium / Low Temperature
(-50°C - 15°C)

Checked By	AS	Scale	1:2
Drawn By	RV	Sheet size	A1
Issue date	24.01.2013	Revision	A
Drawing No.	IWC-XGA-ML		
Sheet	8 of 9		

